

logan

ficha técnica

datasheet

ref. 5551807

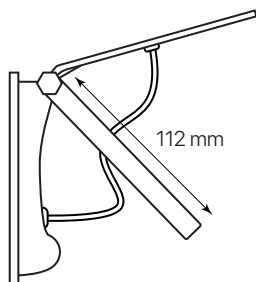
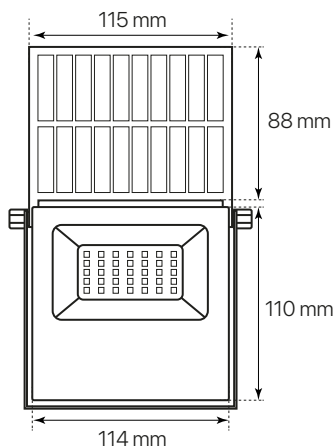
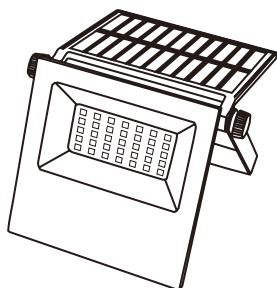

Nombre / Name	Logan
Referencia / Reference	5551807
Materiales / Materials	Aluminio / Aluminum
Difusor / Diffuser	Cristal / Glass
Potencia / Power	30W
Temperatura de color / Color temperature	6500K
Flujo luminoso / Luminous flux	350lm
Dimable / Dimmable	No
Ángulo de apertura / Beam angle	90°
Ángulo de detección / Detection angle	-
IP	65
IK	3
F.P	-
UGR	-
IRC	-
Chip	San'an High Quality
Driver	-
Vida media (duración) / Average life	50.000H
Clase energética / Energy class	A
Aislamiento eléctrico / Electrical isolation	Clase III / Class III
Colores / Colors	Negro / Black
Medida exterior / Product size	139mm x 116mm x 35mm
Medidas de corte / Cutting measurements	-
Tª (ambiente/trabajo) / Tª (environment/work)	0 ~ 40°C
Input	5V
Output	3.2V
Frecuencia / Frequency	-
Peso / Weight	456g
Certificados / Certificates	CE RoHS
Garantía / Warranty	2 años / 2 years